TELEDESIC BROADBAND CENTER FIELD STUDY

SUMMARY REPORT
APRIL 2002

TOM WEBSTER, P.E.
RACHEL BANNON
DAVID LEHRER, AIA

CENTER FOR THE
BUILT ENVIRONMENT



ACKNOWLEDGMENTS

The authors wish to thank the Teledesic Broadband Center project team members who provided the researchers with invaluable information and insight: Steve Fisher, Teledesic; Brent Rogers, NBBJ; Alisdair McGregor, Arup; Tom Watson, Arup; and Allan Daly, Taylor Engineering, (who was with Arup during this project). We would also like to thank our colleagues at the Center for the Built Environment for their time and support: Fred Bauman, Gail Brager, Charlie Huizenga, and Kathryn Laeser.

The Center for the Built Environment (CBE) was established in May 1997 at the University of California, Berkeley, to provide timely unbiased information on promising new building technologies and design strategies.

The Center's work is supported by the National Science Foundation and CBE's Industry Partners, a consortium of corporations and organizations committed to improving the design and operation of commercial buildings.

CBE's Industry Partners:

Armstrong World Industries
Arup
California Department Of General Services
California Energy Commission
HOK
International Facility Management Association (IFMA)
NBBJ
Pacific Gas & Electric Co.
Skidmore Owings And Merrill, LLP
Tate Access Floors, Inc.
Taylor Engineering Team: Taylor Engineering, The Electrical Enterprise, Southland Industries, Swinerton Builders
Trane
U.S. Department Of Energy (DOE)
U.S. General Services Administration (GSA)
United Technologies Corporation
Webcor Team: Webcor Builders, Critchfield Mechanical, Rosendin Electric, C&B Consulting Engineers
York International Corporation



Center for the Built Environment (CBE)
An NSF Industry/University Cooperative Research Center
390 Wurster Hall #1839, Berkeley, CA 94720-1839
tel: 510.642.4950 fax: 510.643.5571
cbe@uclink.berkeley.edu www.cbe.berkeley.edu

TABLE OF CONTENTS

1. Executive summary
 - 1.1 Project description and field study approach
 - 1.2 Summary of research findings
2. Project background
 - 2.1 Project description and design intentions
 - 2.2 Climate description
 - 2.3 Underfloor air distribution system description
 - 2.4 Underfloor air distribution system operation
3. Field study and survey methodology
 - 3.1 Field study scope
 - 3.2 Underfloor air distribution testing methodology
 - 3.3 Thermal stratification testing methodology
 - 3.4 Energy Management Control System data collection and analysis
 - 3.5 Sound level measurement methodology
 - 3.6 Occupant survey methodology
4. Field Study Findings
 - 4.1 Building occupancy and system operation history
 - 4.2 Energy Management Control System data findings
 - 4.3 Underfloor air distribution system operation findings
 - 4.4 Thermal stratification findings
 - 4.5 Supply air temperature distribution
 - 4.6 Annual energy use
 - 4.7 Acoustical findings
 - 4.8 Occupant survey findings
 - 4.8.1 Workspace and general satisfaction
 - 4.8.2 Raised floor and floor diffusers
 - 4.8.3 Thermal comfort
 - 4.8.4 Acoustic and visual privacy
 - 4.8.5 Lighting quality
5. Conclusions and implications for design
6. Appendix 1: Summary of field measurements

I EXECUTIVE SUMMARY

1.1 Project description and field study approach

The design of many unconventional internet and technology office spaces in the late 90's has challenged many standard conventions of workplace protocol. Although it is easy to poke fun at the free café lattes, foosball machines, and dogs in the office, the desire to create a workplace that is healthier, more functional, and casual is seen by many as a positive and continuing trend. The question then arises, how well do these new innovative workplaces actually perform?

The Teledesic Broadband Center, in Bellevue, Washington, is one example of this new office paradigm. Designed by the architecture firm NBBJ of Seattle in conjunction with mechanical engineering firm Arup of San Francisco, the project is an adaptive reuse of an industrial building to create the new headquarters for Teledesic, a company that is building a global broadband communications network. The design of the 70,000-square foot space incorporates many new workplace features, including a high loft-style ceiling, an open workstation plan, an open mezzanine, and an underfloor air distribution (UFAD) system that allows occupants to control the airflow to their individual workstations.

A field study of the Teledesic offices was conducted during the winter months of 2000/2001 to gain both quantitative and qualitative insight into the building's performance. This study, carried out by researchers from the Center for the Built Environment (CBE), included several specific research objectives:

1. Assess occupant satisfaction and comfort.
2. Evaluate the operation of the underfloor system.
3. Assess the underfloor system energy performance.
4. Understand the interactions between building design characteristics and the underfloor system.
5. Investigate the thermal stratification in the high ceiling area.

The study included two site visits for detailed observation and data collection, an on-line survey of the building's occupants, and interviews with the project design team. During the first site visit the research team gathered building and occupancy information and installed automated sensors that would record air temperatures at multiple locations over a six week period. During a second visit the research team retrieved the sensors and collected data, and made final observations. Measurements of the indoor environment using hand held equipment were made during both visits.



View of lounge and library area

1.2 Summary of research findings

The field study revealed that when the building is in a heating mode the thermal environment of Teledesic is uniform throughout the space both horizontally and vertically. In light of the high floor-to-ceiling dimension and large open plan office space, this is a surprising finding.

Current research indicates a correlation between high occupant satisfaction and buildings that offer a level of occupant control (e.g. operable windows or floor diffusers) and a relationship between internal and external environmental patterns. However, despite the thermally uniform interior, and a large percentage of occupants who have never adjusted their floor diffusers, occupant satisfaction in Teledesic was relatively high regarding thermal comfort (68% satisfied) and the operation of the underfloor air distribution system (79% satisfied). Other features of the interior-acoustic and visual privacy-were the source of significant occupant dissatisfaction (82% dissatisfaction for sound privacy, and 61% dissatisfied with visual privacy). Poor sound privacy may be due in large part to the absence of significant masking background noise. In general, these findings are consistent with other research on open plan workplaces¹.

It is apparent from this study that from a thermal comfort point of view the building performs very well in wintertime. However, responses from the occupant satisfaction survey tell us that the flexibility of the UFAD system is not being exploited by occupants in a way that could increase the overall satisfaction level.

Figure 1.1
Occupant satisfaction
survey results

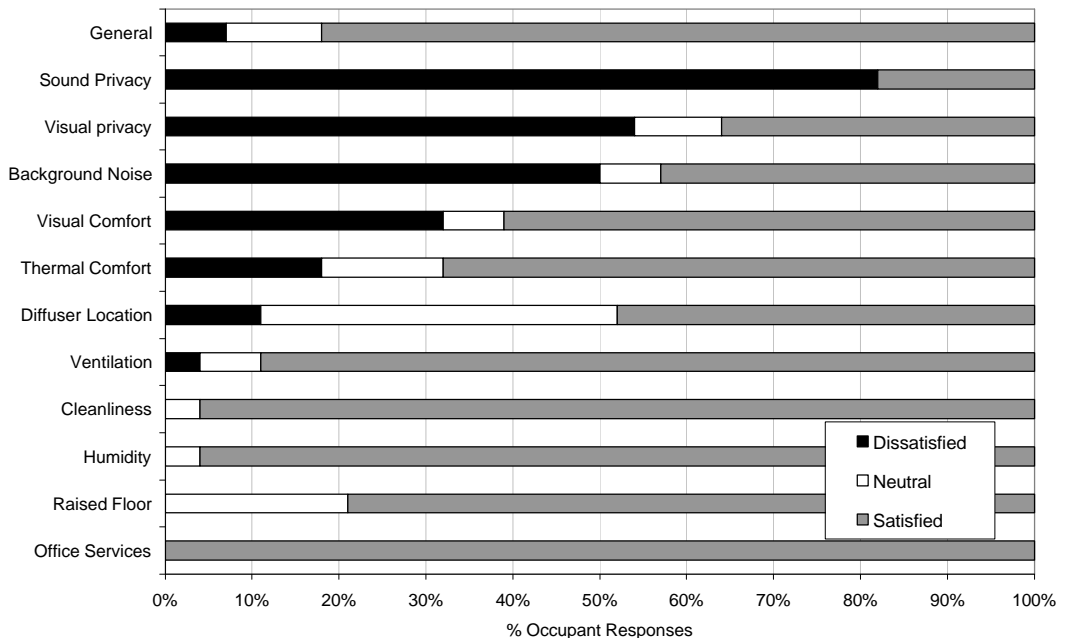

2 PROJECT BACKGROUND

2.1 Project description and design intentions

The design and development team had undertaken the conversion of a 71,000 square-foot (6600 m²) space within a tilt-up concrete warehouse into offices for Teledesic, a company developing satellite communication systems technology. The project scope included a complete interior architectural design and the upgrade of the building's insulation and openings. Loading dock doors on the south elevation were fitted with colored-glass windows, skylights were added, and large windows were added high on the north façade.

The architects for the project, from NBBJ's Seattle office, maintained the large floor-to-ceiling height throughout most of the space. A 19,000 square-foot (1765 m²) mezzanine occupies one third of the volume and divides the building into two zones, the reception area to the north, and the open office area to the south. Several conference rooms and a kitchen are located underneath the mezzanine. The open office area consists of workstations and open team spaces with lounge seating and coffee tables. Since there are no private offices in the building, a variety of conference rooms are available for private conferences and meetings in the core area below the mezzanine.

One of the design team's primary objectives was to meet Teledesic's desire for an office that would stimulate creativity and innovation. Internal planning was guided by the client's preference for open, flexible workstations interspersed with lounge areas. The architects describe the straightforward use of materials and exposed structure as a "garage/airplane hangar aesthetic" and exploited the floor-to-ceiling height to create a space that feels "larger than life." This attitude is reflected in the size of the high windows in the south façade, which extend from a 10-foot (3 m) sill level to the ceiling, and are internally shaded by fixed metal mesh screens. In addition large

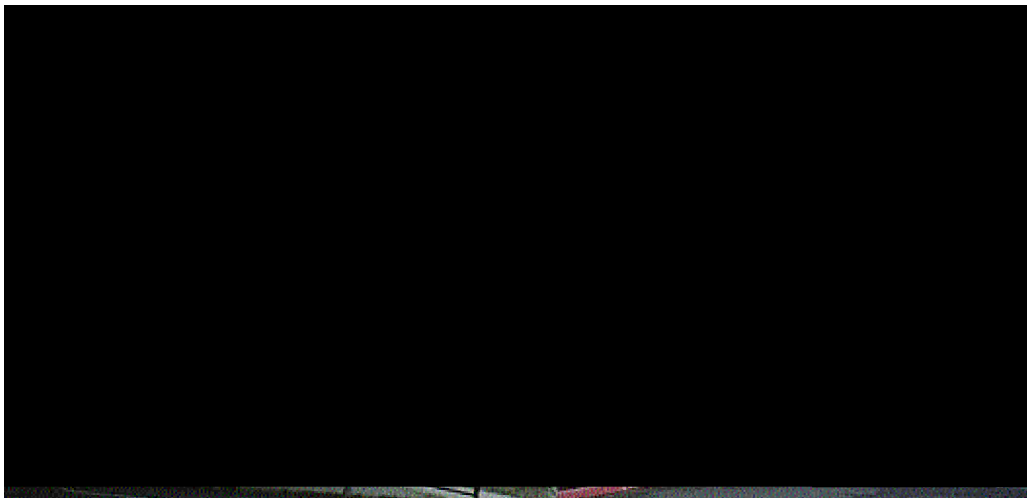

Exterior view of north elevation and entry

Table 2.1 Project description and development team	LOCATION	Bellevue, Washington, USA (47 latitude, elevation 386 ft)
	SIZE	A total area of 71,000 ft ² (6600 m ²) accommodates the main floor and a 19,000 ft ² (1765 m ²) mezzanine
	OCCUPANCY	The offices of Teledesic, a technology company developing satellite communication systems technology. The building is typically occupied Monday-Friday, 9 am to 5 pm
	COMPLETION	July 1999
	OWNER/DEVELOPER	Teledesic
	ARCHITECT	NBBJ, Seattle
	MECHANICAL ENGINEER	Arup, San Francisco
	LANDSCAPE ARCHITECT	Allworth/Nusbaum
	ACOUSTICAL ENGINEER	Michael Yantiz
	MECHANICAL CONTRACTOR	McKinstry Company

skylights and small low-level windows were added to admit daylight. The lighting design consists of overhead HID fixtures with workstation task lighting and suspended direct/indirect fluorescent fixtures in the mezzanine area.

The large volume of the space combined with the client’s programmatic requirements led the design team to pursue an underfloor air distribution (UFAD) system for several reasons. Designing a conventional overhead system with a 24-foot ceiling would have presented problems in terms of maintaining supply air temperatures at the occupied level. The underfloor system eliminated the need for overhead cable trays, ducts and other mechanical components, and eliminated conflicts with lighting locations. It was also determined that an access floor was needed to serve the company’s data and telecommunications requirements, so a UFAD system was found to be cost effective. Finally, the improvements in indoor air quality that underfloor systems offer was one additional selling point for the design team and client.

The architect’s direct approach to materials is evident in the design of the raised floor itself, with different floor tiles and finishes that break the large space down into separate zones. The main open office area is laid out with 24-inch (600 mm) carpet tiles, laid non-coincident with the floor panels. Exposed concrete floor panels in the reception and circulation areas include tinted spotlights installed flush with the floor surface. In the north lounge area, bare metal floor panels are accented with area rugs.

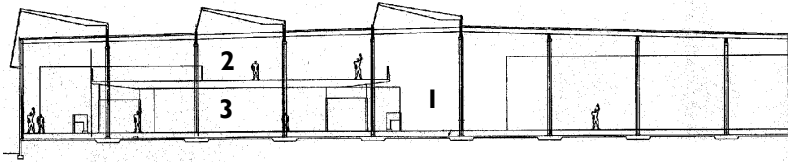

Figure 2.1
Building section

- 1 Open office area
- 2 Mezzanine
- 3 Conference and work rooms

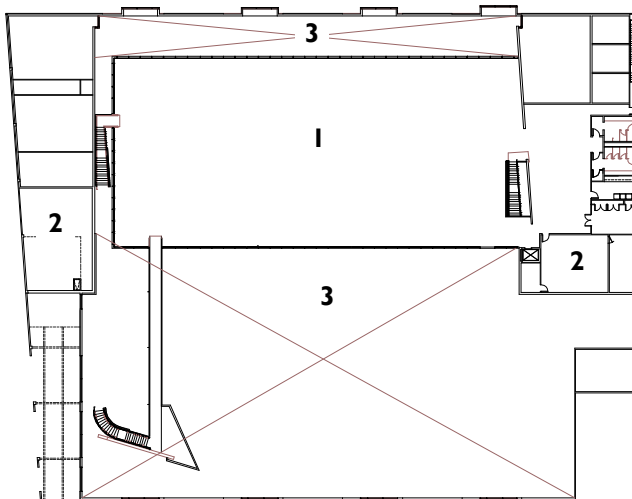

Figure 2.2
Mezzanine level plan

- 1 Mezzanine open office area
- 2 Mechanical
- 3 Open to below

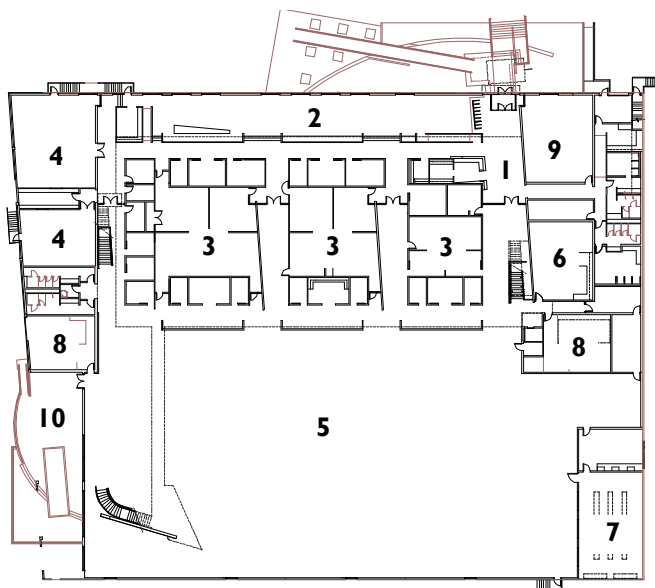

Figure 2.3
Ground floor plan

- 1 Lobby/reception
- 2 Library/lounge
- 3 Small conf. rooms and work rooms
- 4 Large conf. rooms
- 5 Open office area
- 6 Supply/copy
- 7 Computer room
- 8 Mechanical
- 9 Retail

2.2 Climate description

Teledesic's Broadband Center is located in Washington's fourth largest city, Bellevue, approximately ten miles east of Seattle. This region of the Pacific northwest experiences mild temperatures, a significant rainy season with a high frequency of overcast days, particularly in the winter. The site's local climate is tempered by the Pacific Ocean and other large bodies of water, and is shielded by the Cascade Mountain Range from the continental climactic extremes of cold winters and hot, dry summers.

Average daily temperatures in winter are 30-40°F (-1-4°C), and in summer are 50-70°F (10-21°C). Prevailing winds are southwesterly, and fog conditions last from late summer to early winter. The rainy season extends from October to March during which time 75% of the annual precipitation falls. Much of this rainfall is brought on by southwesterly winter storms, turning northerly in severe cases as they move through western Washington. As a result snow depth is variable, generally only falling when storms have brought cool air directly from Canada

Figure 2.4 presents climate data for the Seattle-Tacoma region and indicates the nature of Teledesic's climatic context. An analysis of heating and cooling degree-days reveals that winter conditions clearly predominate for the majority of the year.

Figure 2.4
Temperature
maximums and
relative humidity for
Seattle-Tacoma region

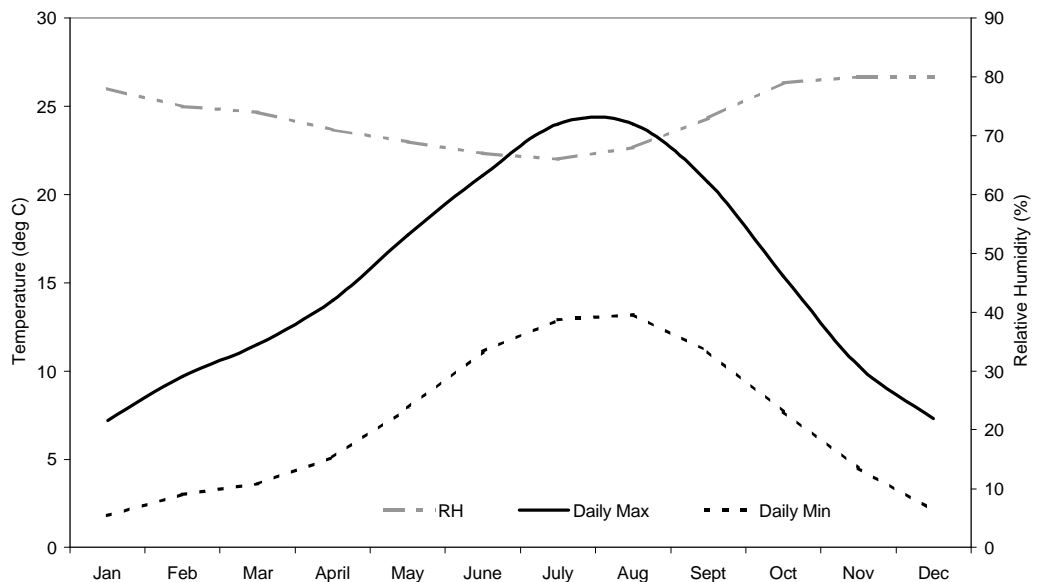

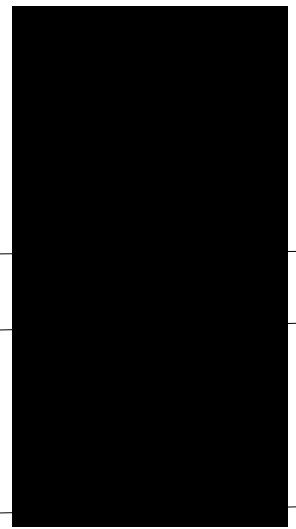
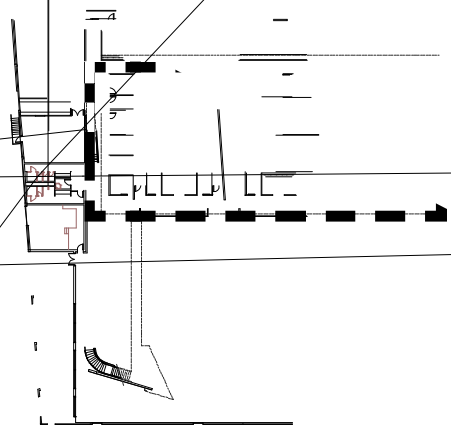
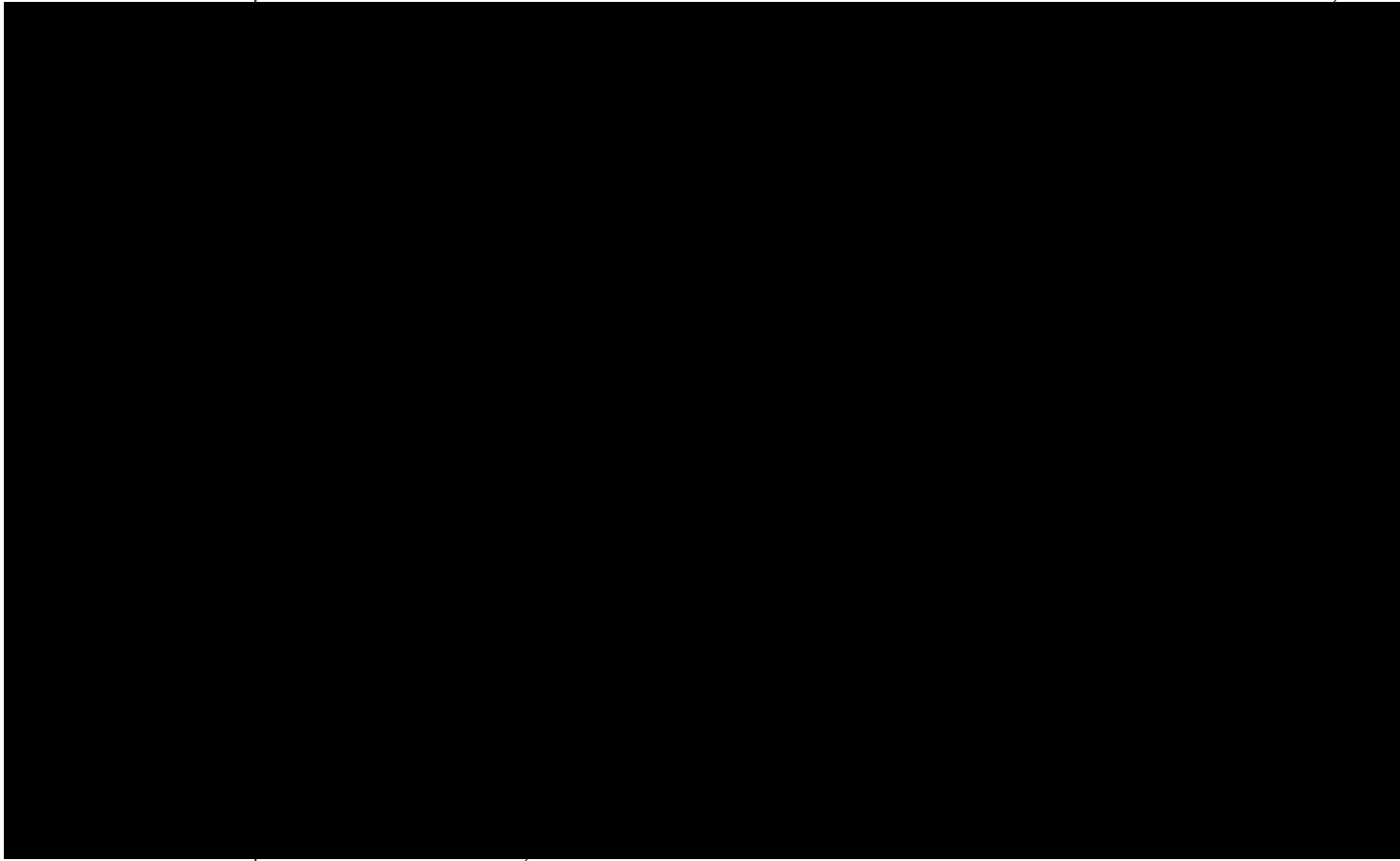

Table 2.2	PLENUM HEIGHT	18-inch (450 mm)
Underfloor air distribution system details	RAISED ACCESS FLOOR	24-inch (600 mm) Interface concrete-core panel
	STRUCTURAL SLAB	6-inch (150 mm) slab on grade (main floor)
	DIFFUSER TYPE	Trox swirl diffuser (core/interior zone)
		Titus linear grille (perimeter zone)
	FAN POWERED VAV BOXES	Titus
	SYSTEM TYPE	Constant volume, variable temperature in perimeter and interior zones
	SUPPLY AIR TEMPERATURE	65°F (18°C) nominal temperature

2.4 Underfloor Air Distribution System Operation

The main workspace zone is operated as a constant volume, variable temperature (CAV-VT) system with supply air temperature controlled by a number of sensors located in the interior zone and linked to the AHU via an Alerton energy-management system. As the building is essentially single story, significant heat loss through the roof in winter causes a variation in the required supply air temperature between 18°C and 21°C (65-70°F) throughout the year. Under normal operating conditions air is returned to the AHU via return grilles located near the ceiling. Alternatively, when the system is using outside air in an economizer mode, return air is exhausted via a roof relief damper.

In the north perimeter zone, cool plenum air is distributed through linear diffusers located in the kick-plates of the cabinets. These diffusers incorporate a two-position damper that minimizes plenum air delivery during heating. Finned tube convectors located along the exterior wall provide heating for this zone.

Other perimeter zones operate as CAV-VT systems with the use of variable air volume (VAV) fan-powered mixing boxes. During intermediate load conditions, room air is drawn into the plenum through linear diffusers, mixed with fresh plenum supply air and re-emitted through diffusers at the perimeter of the zone that are connected to the mixing box via flexible ducts. Although each zone operates as CAV system, for the system overall the supply air volume varies to some degree as the fan-powered boxes reduce the percentage of plenum air used. In winter, the percentage of plenum air used is the minimum necessary to satisfy fresh air requirements, with re-circulated room air comprising the majority of the volume of supply air.

Two large conference rooms located adjacent to the west exterior wall and two small internal conference rooms use distinct UFAD system configurations. The large confer-

ence rooms are the only spaces with plenum partitions. Operating as a VAV system in response to signals from a room thermostat, supply air is ducted directly from the AHU to a VAV box serving this plenum zone. In the small conference rooms plenum air is supplied via swirl diffusers. Ducts connect additional diffusers to a small variable speed fan, operated by a multi-step manual control switch. This enables occupant control over the level of cooling provided, a unique feature for an intermittently occupied space such as a conference room.

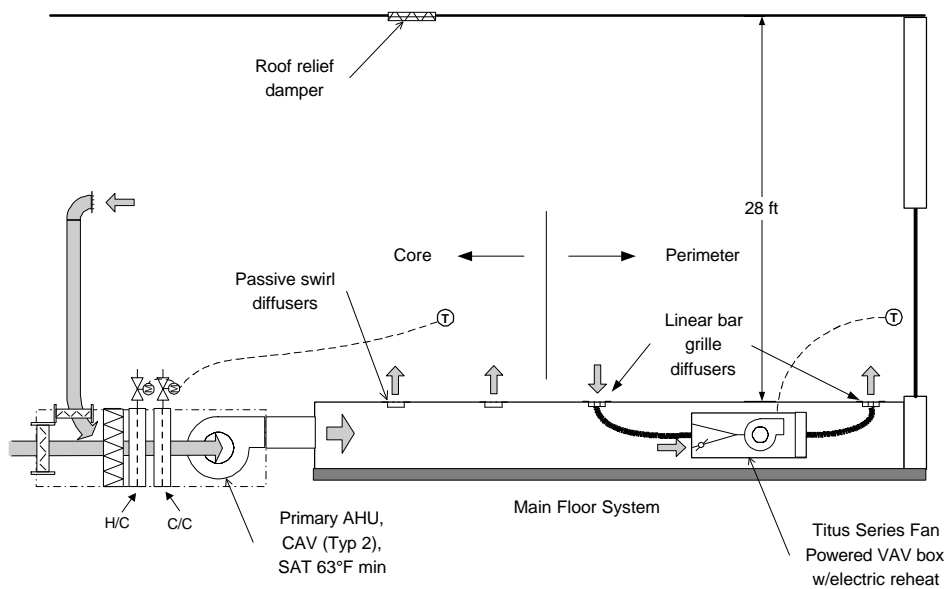

Figure 2.6
Underfloor system
schematic, south open
office area

3. FIELD STUDY AND SURVEY METHODOLOGY

3.1 Field study scope

An initial review of the project drawings and data allowed the investigation team to develop a series of research questions and goals. Teledesic's climate, with cold, wet winters, suggested that winter would be a problematic season for maintaining thermal comfort. Typical conflicts between the need for cooling in interior zones, heating at the perimeter, and the project's large, high single volume would present challenges for the system designers and operators. Thus any assessment of the building's performance should include consideration of winter conditions.

A literature search into UFAD systems discovered an overwhelming majority of research papers, proceedings and general information focused on summer operation in

a cooling mode with very little information on wintertime operation. Very little documentation indicates to what degree UFAD systems are able to successfully transition from cooling in the interior zones to heating at the perimeter, and achieve comfortable thermal conditions on a cold winter day. Consequently the field study was developed to fill this gap in the research literature.

3.2 UFAD testing methodology

Execution of this study consisted of initial preparation and two site visits. The initial field visit was conducted over a two day period in December, 2000 to observe and document indoor environmental conditions, and install automated temperature sensors with memory capacity-“data loggers”-for extended time monitoring. The data loggers were programmed to record air temperatures for a period of 45 days, at two-minute intervals. Seven weeks later a single-day visit took place during which all data loggers were retrieved and measurements were made with hand-held devices to provide a detailed snapshot of the system at one point in time². These measurements included room air temperature and relative humidity levels taken along two axes, N/S and E/W on both floor levels.

The investigation team was interested in monitoring supply air temperatures to establish relationships between room air and supply air temperatures in order to study thermal decay. Data loggers were placed in floor diffuser baskets at 20 locations on the ground floor and mezzanine. The locations were chosen to obtain a range of different plenum conditions, such as next to fan terminal units, in the perimeter zones, or in core areas. To compliment this temperature monitoring, spot measurements of the air velocity and sound pressure level were taken, both within and immediately above each floor diffuser containing a data logger. A complete list of field measurements is summarized in Appendix 1. The locations for data collection are shown in Figure 3.1.

3.3 Thermal stratification testing methodology

For the purpose of studying thermal stratification, two strings of nine data loggers were installed at two columns, one in the interior of the main floor and one near the perimeter. The data loggers on each string were at 1 ft intervals from 1 ft (0.3 m) above ground level to 9 ft (2.7 m). In addition, a single data logger was taped to the mezzanine balustrade at a height of 17 ft (5.2 m).

3.4 Energy Management Control System data evaluation

Investigators accessed the building’s Alerton Energy Management and Control System (EMCS) to identify basic system operating parameters and review trend logs dating back to 1999. This information had the potential to allow the team to collect a comprehensive set of data that would illustrate characteristics of the UFAD system’s operation over the entire year.³ The information collected from the EMCS is illustrated in Table 3.1.

3.5 Sound level measurement methodology

The sound survey consisted of recording 'A' weighted decibel levels with a hand-held digital sound level meter along a central E-W line on the main floor to measure background noise levels. The location of the sound level measurements is shown on Figure 3.1. Two methods were used to gauge acoustical performance in addition to occupant's responses from the satisfaction survey:

1. *Speech interference from background noise.* The background noise levels (dBA) beyond which speech interference occurs is shown in Table 4.3. These levels were derived from Speech Interference Level (SIL) acceptability criteria as described by Salter⁴.

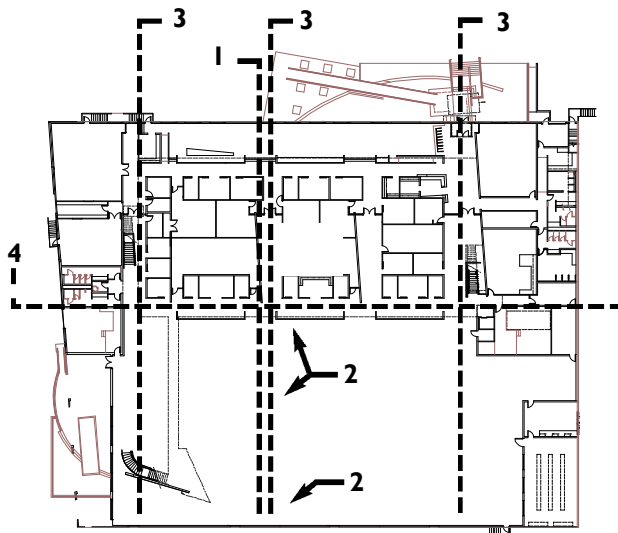

Figure 3.1
Data collection locations

- 1 Diffuser temperature data collection line
- 2 Thermal stratification data locations
- 3 Room air temperature data collection lines
- 4 Sound level data collection lines

DATA FOR AHU-1

Supply air temperature (SAT)
Set point temperature (STP)
Room air temperature (RMT)
Mixed air temperature (MAT)
Return air temperature (RAT)

DATA FOR PERIMETER MIXING BOX

Discharge air temperature (DAT)
Outside air temperature (OAT)
Room air temperature (RMT).

SLAB TEMPERATURES

Four channels corresponding to 3 main floor sensors and one for the mezzanine

Table 3.1

Energy Management and Control System data

2. *Noise Criteria Ratings.* Table 4.3 also shows typical noise criteria (NC) ratings and their equivalent dBA levels for various office environments. These were also derived from converting NC ratings to dBA levels as described by Salter.⁴

3.6 Occupant survey methodology

Building occupants are a valuable source of information on the performance of a building design and its operation. As part of the Teledesic case study, a Web-based survey to study the comfort and satisfaction of the occupants was administered. All building occupants were sent emails requesting their participation in the survey, and explained that their participation would be voluntary and anonymous. The survey identified the following ten general areas of the building and work environments and asked respondents to evaluate their satisfaction with several aspects of each :

1. Workspace and spatial layout
2. Office support services
3. Raised floor
4. Floor diffusers
5. Furnishings
6. Thermal comfort
7. Air quality
8. Lighting
9. Acoustics
10. Cleanliness and maintenance
11. General satisfaction

The survey employed yes/no questions and 7-point satisfaction scales that ranged from “very satisfied” to “very dissatisfied”. In most cases respondents that indicated dissatisfaction (the lowest three points on the scale) with a particular aspect were given additional questions about the nature of their dissatisfaction. Respondents who indicated higher satisfaction moved directly to the next survey topic. In some cases respondents were asked to assess the impact of the work environment on their ability to accomplish their work. The survey also included space for respondents to make comments, including a “general comments” section at the end of the survey.

Figure 3.2
Occupant satisfaction
rating scale



4. FIELD STUDY FINDINGS

4.1 Building occupancy and system operation history

The project's architects and engineers reported that the project as a whole had run smoothly and was considered by mechanical engineers at Arup to be an exemplary UFAD installation. However, the facility managers found that several adjustments to the supply air temperatures were necessary during the early stages of occupancy. The first adjustment was made in response to cold complaints during the building's first winter occupation. The supply air set point temperature was raised to compensate for these complaints. The low internal air temperature could have been the result of:

- ♦ Lack of significant stratification in the tall double height space resulting in lower than expected occupied zone temperatures.
- ♦ The building was operating at a reduced occupancy and had lower internal gains than anticipated.
- ♦ The floor slab had not yet reached equilibrium and at 55-60°F (12.8-15.6°C) was colder than expected, thus reducing the diffuser supply air temperatures below that required.

Another adjustment was made during the first summer when the building was fully occupied. The mezzanine level would become much warmer than the ground floor due to the accumulation of rising heat from the ground floor, and internal gains generated on the mezzanine. As a result the supply air temperatures on the mezzanine were adjusted to be significantly lower than those on the ground floor. However, after the onset of the cooler winter months and the reduction in occupancy of the mezzanine level, supply air temperatures to the mezzanine had not been reset. The lower temperatures measured at the upper level are therefore probably due to a pooling of cooler supply air no longer needed to offset internal and external gains.

The space had been designed to accommodate 170 workstations, 112 on the ground floor, and 58 on the mezzanine level. Unfortunately due to the dramatic downturn in the economy, by the time of the first site visit only 75 employees occupied the space, and the mezzanine was completely vacant. By the time of the second visit this number had fallen to 42 (only 32 were present during the site visit). The difference between estimated and observed heat loads for occupants, task lights and computer equipment, is shown in Table 4.1. Although not a comprehensive estimate of all internal gains, this basic comparison illustrates the significant difference between maximum estimated and actual internal heat loads.

In addition, design stage ventilation calculations were based on 170 people at 20 cfm/person. This turned out to be far in excess of the requirements for the reduced occupancy. Although potentially beneficial in the summer cooling season, low internal gains and a higher than necessary air flow rate could potentially create problems of low internal air temperatures in the winter heating season.

Table 4.1
Estimated versus
observed internal
loads.

LOAD	ASSUMED POWER RANGE (KW)	NUMBER OF SOURCES	OBSERVED TOTAL POWER (KW)	OBSERVED TOTAL (KBTUH)	ESTIMATED LOAD (KBTUH)
OCCUPANTS	0.07-0.08	32	2.24-2.56	7.6-8.7	184
COMPUTERS	0.16-0.35	32	6.72-14.4	22.9-49.1	359
TASK LIGHTS	0.05-0.132	32			

4.2 Energy Management Control System data findings

System operation and control. The building is operated by five basic subsystems (south and west perimeter, interior main, conference rooms, mezzanine, and north perimeter) each with an independent control strategy, although each is influenced by others. The primary air supply to all systems is provided by three AHUs, two on the main floor and one on the mezzanine. The supply air temperature (SAT) for the AHUs is controlled by a reset strategy based on readings from interior zone thermostats with respect to their set points. Consequently operation of the AHU is driven by interior loads, and provides either heating or cooling as required to meet the supply air set point if the economizer mode cannot meet SAT requirements. The supply air temperature set point for main floor AHUs is reset according to an average reading from two interior room temperature sensors.

The perimeter systems operate independently of the AHU. Each fan-powered mixing box draws air from the plenum and/or the room to supply air at a variable temperature and constant volume - the box discharge air temperature (DAT) is controlled by deviation from the set point of the zone temperature sensor.

The EMCS data describes the UFAD system's weekday operation from startup at 3:45 am to shutdown at 9:00 pm. During the period from 3:45 am to 5:00 am, a morning warm-up mode with the outside air dampers closed provides heating if necessary to meet the SAT requirements.

As illustrated in Figure 4.1, heating occurs during winter operation from a mixed air temperature (MAT) of 66-68°F (18.8-20°C) to a 71.5°F (21.9°C) supply air temperature (SAT). The temperature increases to 73°F (22.7°C) in the room followed by a drop to 71.5°F (21.9°C) at the return. The reason the return air temperature is cooler than room air may be due to the cooler supply air temperatures at the mezzanine level, as explained earlier. The outside temperature was in the range of 30-40°F (-1-4°C) during the day represented in this graph.

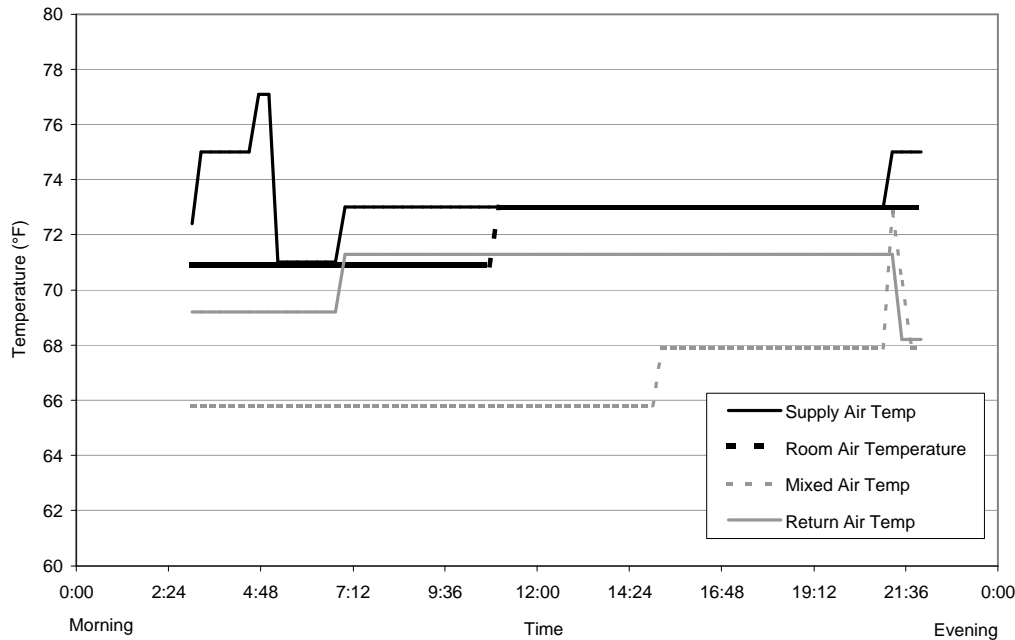

Figure 4.1
Temperature profiles
under winter day
operation

On a typical winter day additional heating of supply air is not required for the main floor internal zone since a supply air temperature of 71.5°F (21.9°C) is adequate to maintain the zone set-point of 73°F (22.8°C).

For control purposes the perimeter fan powered mixing boxes are “ganged” in groups of three. One box serves as a master to which the zone temperature sensor is connected. The operation of the two slave boxes is intended to replicate that of the master. In several cases it was found that only the master was operating its reheat coils; the slaves’ outlet temperatures were not consistent with the high temperatures (~100-120°F, 37.8-48.9°C) of the master. In addition, the zone temperature was 68°F (20°C) while the set-point was 71°F (21.7°C). There appeared to be a problem with either the control logic or the reheat coils for the slave boxes. Since the building was so sparsely populated this may not have been perceived, or reported as a complaint.

In addition, the baseboard heating system in the north zone was operating at ~70°F (21.1°C) with a set-point of 73°F (22.8°C). The boiler appeared to be operating at 100% capacity which indicates it may be either slightly undersized, or that its supply water temperature needs to be increased for this cold day condition (~35°F, 1.7°C).

Examination of summer day operation from trend logs indicates the system was able to maintain a 73°F (22.8°C) space temperature with a 68°F (20°F) SAT. However, the data indicated some anomalies in the control strategy, which could not be deciphered

Table 4.2	DATE	MAIN-SOUTH (°F)	MAIN-NORTH (°F)	MAIN-EAST (°F)	MEZZANINE (°F)
Slab operating temperatures	SUMMER OPERATION (DATA 6/20/99)	68.7	66.5	69.2	70.2
	WINTER OPERATION (DATA 1/15/00)	70	70.8	70.3	72.5

from the available control documentation. For example, the SAT temperature reset range is listed to be from 62°F (16.7°C) to 73°F (22.8°C) with the room temperature set point listed as 71°F (21.7°C) with a 1°F offset for heating and cooling. However, the cooling data shows a SAT of 68°F (20°F) minimum even when 62°F (16.7°C) was being called for. Yet in winter the space temperature is maintained at 73°F (22.8°C) with a 73°F SAT; it is not clear what sort of reset strategy would accommodate these two conditions.

Slab Temperatures. Based on data starting in 1999, slab temperatures from the three main floor sensors were between 66 and 69°F (18.9-20.6°C). By January 2000 these temperatures were all consistently reading about 70°F (21.1°C) with the mezzanine about 2°F (1.1°C) greater. Table 4.2 summarizes these results⁵.

4.3 UFAD system operation findings

Typical patterns of room air temperatures recorded by the stratification measurement data loggers in the interior zone of Teledesic’s workspace over a one week period are shown in Figure 4.2. These temperatures rise steadily from early morning as internal gains accumulate, and decrease in the evening as computers and task lights are turned off, and occupants leave and the UFAD system shuts off. Figure 4.3 illustrates the variations for a single 24-hour period. All temperatures from 1-foot (0.3 m) up to a height of 7-feet (2.1 m) follow this regular pattern. The magnitude of these variations is approximately 3.5°F over a 24-hour period.

To document room air variation throughout the building, measurements were taken with hand held devices at 4 ft (1.3 m) above the floor level from north to south along three lines within the building, as shown in Figure 3.1. The readings are illustrated in Figure 4.4. The noticeable dip in room air temperatures to the north occurs within the glazed entry area. This temperature drop is due to the combination of northern exposure, fully glazed entrance doors that are frequently opened, and minimal internal gains from intermittent occupancy. (The receptionist seated in this area has installed a large portable electric heater.) Passing through the glazed doors separating the entry

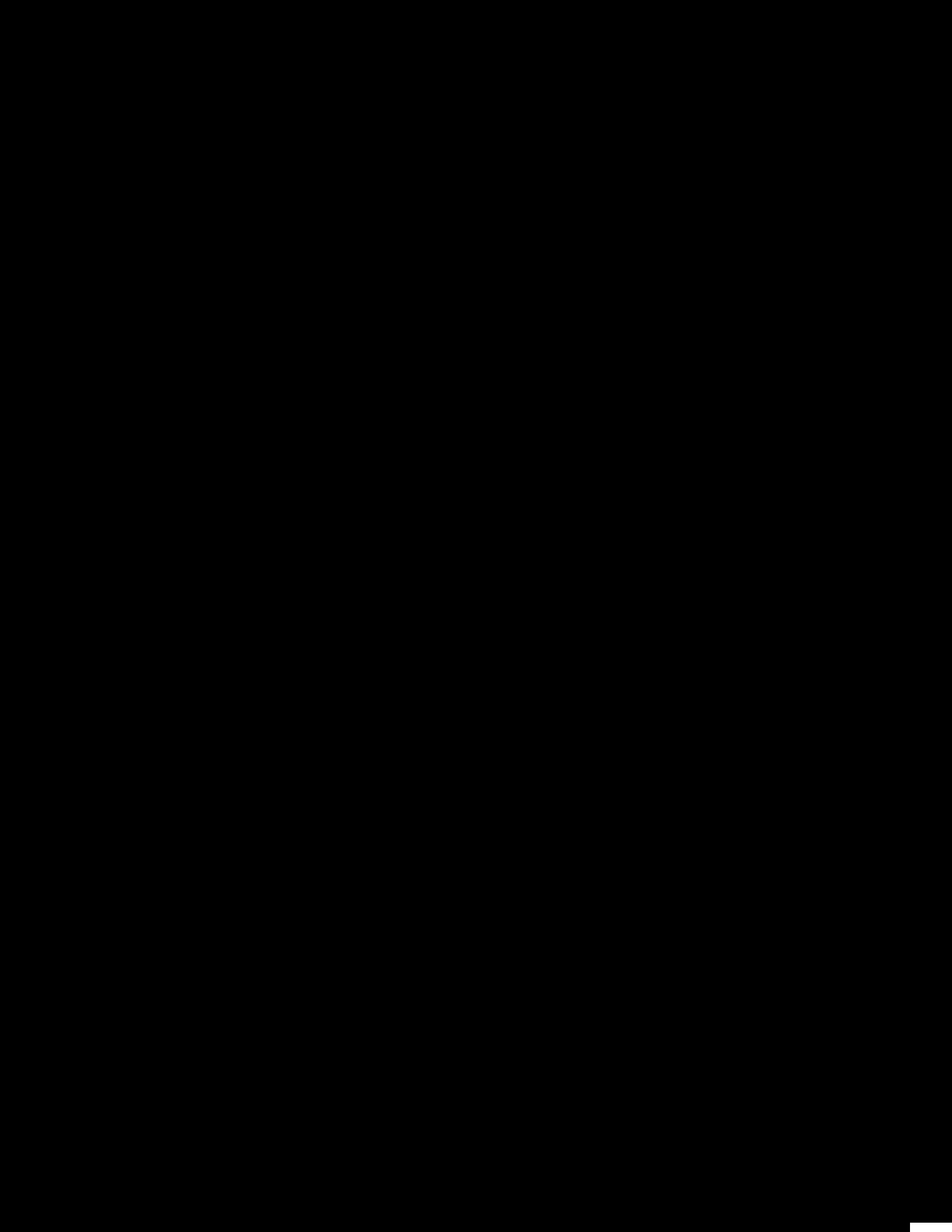
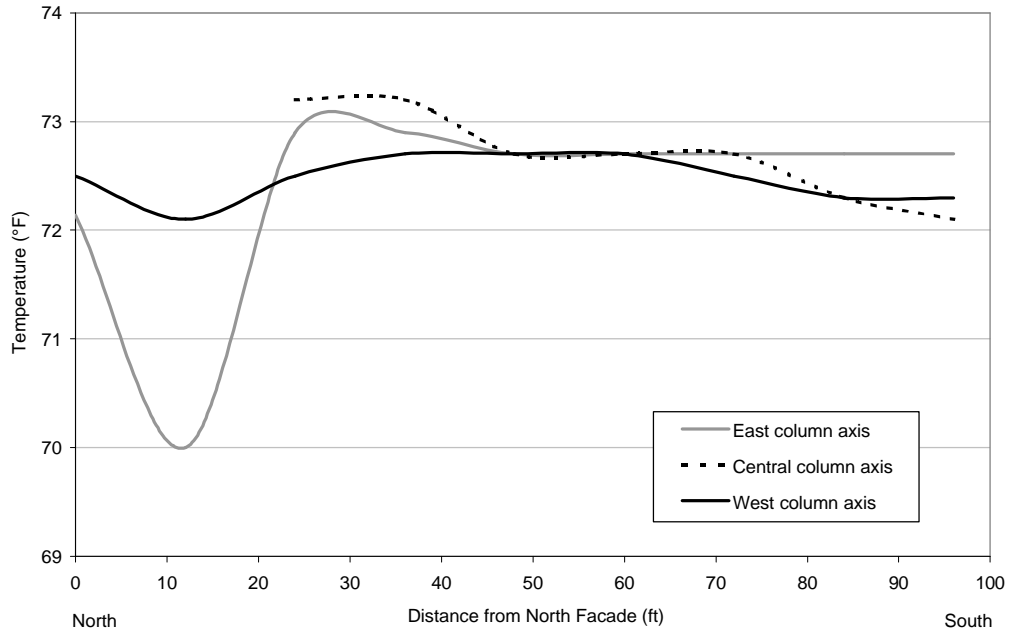

Figure 4.4
North-south variations in room air temperature



from the main workspace area there is a perceptible temperature difference. However within the main workspace area variations in room air temperatures are within about 0.5°F (0.28°C).

Comparison of the data from the two strings of data loggers show that the internal zone was generally 2°F (1.1°C) higher than those recorded in the south perimeter zone. This difference is expected since the perimeter zone is operating at its heating set-point [70°F (21.1°C)] and the internal zone is operating at its cooling set-point (estimated to be 73°F (22.8°C)). Internal gains in the interior and potential fabric heat loss in the perimeter zone cause these temperature differences. The magnitude of this difference is more pronounced as temperatures fall during the evening, and are less during the working day.

Analyzing the entire data set as a whole, Teledesic's internal environment appears to be that of environmental uniformity within and between zones (south, east, west, and mezzanine), except for the north zone where temperatures are somewhat lower due to the proximity of the front door, low internal loads, and significant heat losses.

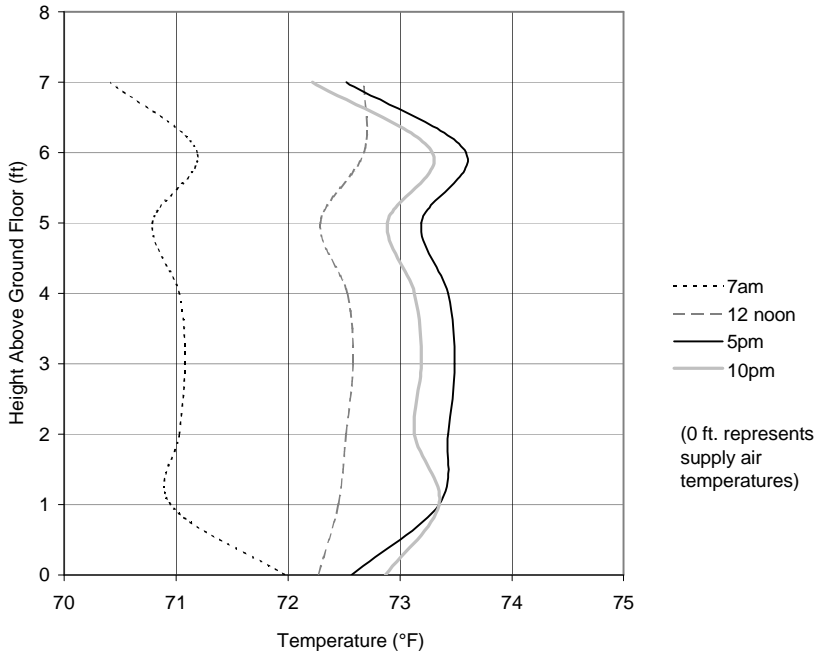

Figure 4.5
Vertical plane temperature profiles over the working day

4.4 Thermal stratification findings

Readings from the strings of data loggers show the vertical distribution of temperatures within the space. Figure 4.5 shows the temperatures recorded at three times during a day at 1 ft (0.3 m) intervals within the occupied zone, generally considered to be from floor level to a height of 6 ft (1.8 m). (The minor variations shown on each data line are not significantly greater than the accuracy and resolution of the data loggers.) As expected, at 7:00 am the room air has cooled overnight while the system was off. The supply air is warmer than the ambient room air temperature at this time of day. (It is not in a heating mode, however.) By noon the supply air temperature is approximately equal to room temperature, operating to maintain conditions close to the set point temperature of 73°F. By 5:00 pm internal gains and room air temperatures have reached their maximum, thus the system supplying light cooling conditions with supply air temperatures lower than room air. During these three distinctive operating conditions, the graph shows a well-mixed internal environment within the first 6 ft (1.8 m) above ground floor level. These results are consistent with other CBE research that has shown that lightly loaded CAV UFAD systems result in minimal stratification within the occupied portion of the zone.⁶

Aside from the mezzanine level, differences in temperatures recorded by data loggers in the occupied zone show variations of only a fraction of a degree. Temperatures recorded at the handrail of the mezzanine (i.e., at 17 ft (5.2 m)), indicate a decrease in

temperature towards the roof level, despite the expectation of warmer temperatures at higher levels. The reason for this observation is due to the adjustment to the air supply temperature made during the first summertime operation, as noted earlier. Otherwise, temperature patterns were remarkably consistent throughout the period recorded.

4.5 Supply air temperature distribution

During the design stage of Teledesic, the mechanical design addressed the risk of thermal decay (undesirable changes of supply air temperatures) throughout the under-floor area. Potential surfaces for thermal transfer included the ground floor slab, the raised floor, and return air ducts. The system was designed with ducts running from the AHUs below the ground floor plenum to supply stub ducts within the plenum that run in a north-south direction. Insulated air highways are used in the mezzanine level. To avoid sub-dividing the plenum attention was paid to defining the maximum possible distance between a discharge duct and floor diffuser before thermal gradients became problematic. Based on previous experience and calculations carried out by Arup, the maximum discharge duct-to-diffuser distance was established as 50 ft (15 m) to ease concerns of long-term temperature problems.⁷

Figure 4.6 shows the relationship between the supply air travel distance and the temperature recorded at that diffuser. This distance includes the total length through

Figure 4.6
Thermal decay of supply air with distance from the AHU

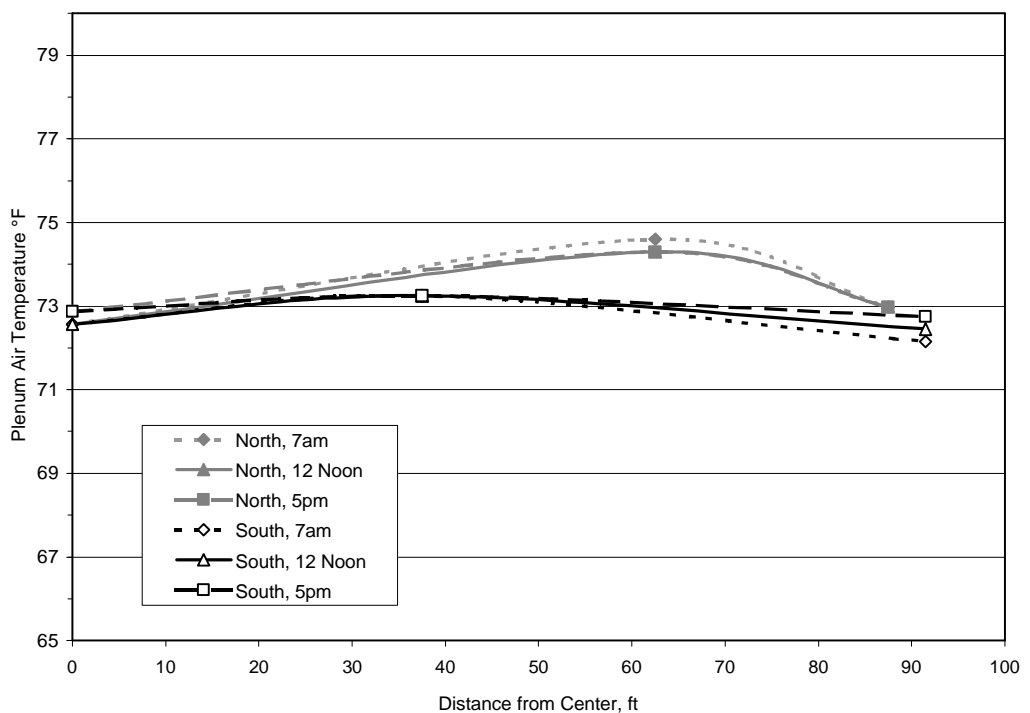

ducts and through the open plenum. Diffuser temperatures were recorded from the mechanical room northward and southward along line "1" shown on Figure 3.1. Supply air temperatures in both north and south zones are highest approximately 20-30 ft (6-9 m) in from the external wall and lowest in the perimeter areas. The temperature differences are relatively small, all within 2°F (1.1°C) of one another. These variations are relatively small, especially when considering the accuracy of measurements. It is also not clear to what effects air flow patterns (e.g., dead spots) in the plenum might have on diffuser supply air temperatures.

Thermal transfer between cool supply air and a warmer slab typically leads to an increase in supply air temperature en route from AHUs to diffusers during cooling mode. The fact that the slab temperatures vary little throughout the year and an observed decrease of only 1-2°F occurs during winter suggests that thermal decay will not be significant in the summer cooling season.

4.6 Annual Energy Use

Figure 4.7 shows the energy use patterns for gas and electric services for the Teledesic Broadband Center based on energy bills for one year (1999). The energy utilization index (EUI) for this building as shown in figure is 76.4 Btuh/sf/yr.

4.7 Acoustical findings

Figure 4.8 shows sound level profile measured in the ground floor open office area. These readings are considerably higher adjacent to the east and west AHUs. Comparisons with Table 4.3 show that the conditions near the equipment rooms were above the acceptable range of 50-55 dBA for open office environments. In the center of the space levels of 46 dBA were recorded, a level typical of private office environments. While taking measurements in the center of the open office area, researchers noted that the background noise level was so low that if a conversation was started at any location the readings increased considerably. This is consistent with occupant survey results which revealed a great concern that conversations could easily be overheard. This indicates that background noise may be too low in most places (most likely exacerbated by the low number of occupants) so that there is no masking effect to reduce the impact of individual conversations.

Figure 4.7
Monthly energy use

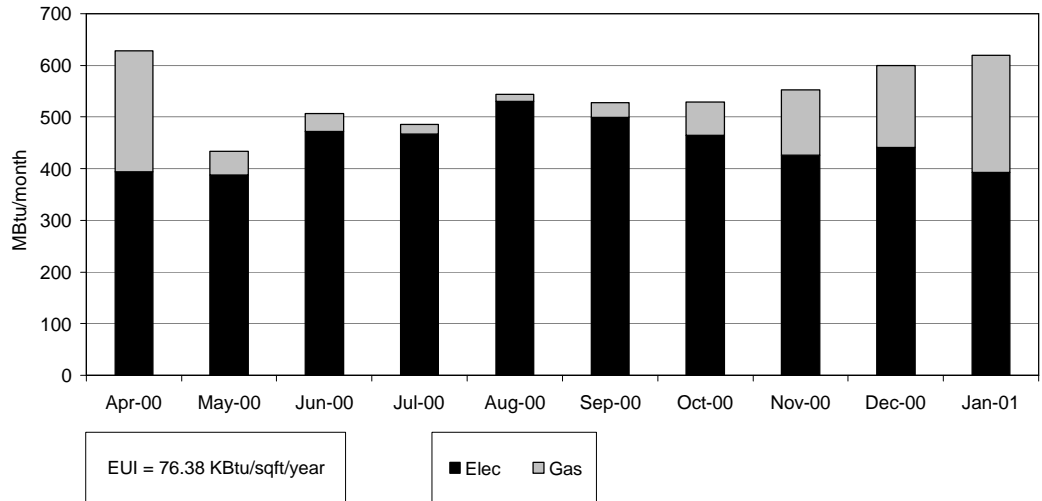

Figure 4.8
Ambient sound level readings



Table 4.3
Acoustical Criteria for Office Environments⁴

OFFICE TYPE	SPEECH INTERFERENCE MAXIMUM ACCEPTABLE (dBA)	NOISE CRITERIA	
		NC	dBA
CLASSROOM	38	25-30	35-45
CONFERENCE ROOM	38-43	25-30	35-40
SMALL PRIVATE OFFICE	53	30-40	40-50
GEN. OFFICE/OPEN PLAN	68	40-45	50-55

4.8 Occupant survey results

As noted previously, the office population was significantly reduced between the two site visits. Out of 42 occupants that were contacted for the survey, 28 survey responses were received. Although the response rate of 67% could be considered a high percentage, the total number of responses is considerably smaller than most of the surveys that CBE has conducted.

For the analysis of the data, responses to each question have been counted in three bins:

- ♦ Dissatisfied, the bottom three points on the 7-point scale
- ♦ Neutral, the middle point on the scale
- ♦ Satisfied, the top three points on the scale

For each question the data is displayed as the percentage of total respondents who responded to the question in each of the three bins. In this way the responses to various questions can be ranked and compared against one another.

General results for the survey are shown in Figure 1.1. Results for selected sections are discussed below.

4.8.1 Workspace and general satisfaction

The responses to the survey show a high level of satisfaction for the workplace design and operation in general. Of those surveyed, 86% responded that they were satisfied with their personal workspace, and 82% were satisfied with the building in general. The major areas for dissatisfaction involved acoustics and visual privacy, results that are not unexpected in an open office environment. High satisfaction results were also recorded for the amount of space for work and storage, and for ease of interaction with co-workers, with satisfaction at 89% in both cases. This is offset, not surprisingly, by 54% of the occupants that are dissatisfied with the visual privacy within the space. Many of these occupants felt that the partitions were too low (9 responses) or that their work area was too dense or overloaded. This is surprising, considering that the office was occupied only by a small fraction of the occupancy it was designed for.

4.8.2 Raised floor and floor diffusers

A measure of a successful HVAC system could be taken as how visually and physically unobtrusive it is and how little attention people pay to it. Judging from the survey results, a majority of occupants pay little attention to the raised floor and the floor diffusers. Occupants were generally satisfied with the raised floor, with 79% satisfied responses and the remainder neutral.

A large majority (88%) of the occupants expressed a preference for the underfloor system as opposed to an overhead system. Occupants were either satisfied with the diffuser locations and settings, or were unaware of their ability to make adjustments:

Left: Figure 4.1

Workspace satisfaction

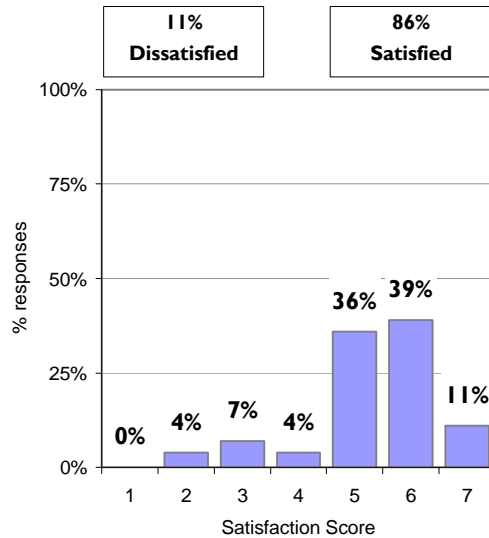

All things considered, how satisfied are you with your personal workspace?

Right: Figure 4.2

General building satisfaction

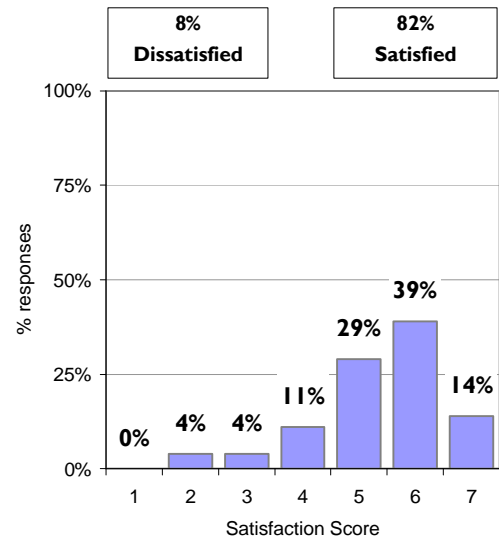

All things considered, how satisfied are you with the building in general?

- ♦ 81% have never adjusted the air flow through the diffusers in their workstation.
- ♦ 0% have requested the removal/relocation/addition of a floor diffuser.
- ♦ 40% have no opinion regarding the location of floor diffusers.
- ♦ 68% have no opinion regarding the number of diffusers in their workspace.

Only 36% of the occupants responded that they believed that adjusting the diffusers can improve one's thermal comfort. This may explain why only 11% have ever tried adjusting their diffuser. This may be the result of occupants' general satisfaction with thermal comfort, or an inadequate understanding of the underfloor system.

Although 89% of respondents were satisfied with the level of air movement in the building, a number of occupants commented that the diffusers blow too much air directly on them. During the field visit a number of occupants were observed sitting almost directly over the diffusers, possibly the result of minor furniture changes or layout coordination problems. Although the recorded data does not allow for such analysis, some of these comments may have been submitted by occupants seated too close to diffusers. Many occupants, 89% of those surveyed, responded that they are within 3-4 feet of a diffuser when seated. (A general design guideline indicates that occupants should not be seated within about a 1-2 ft radius of a diffuser.)

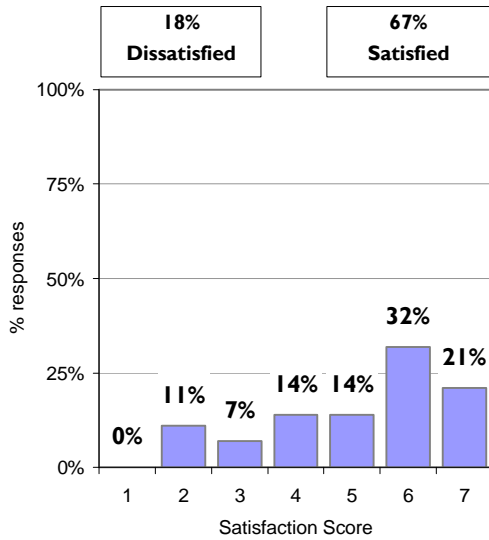

How satisfied are you with the temperature in your workspace?

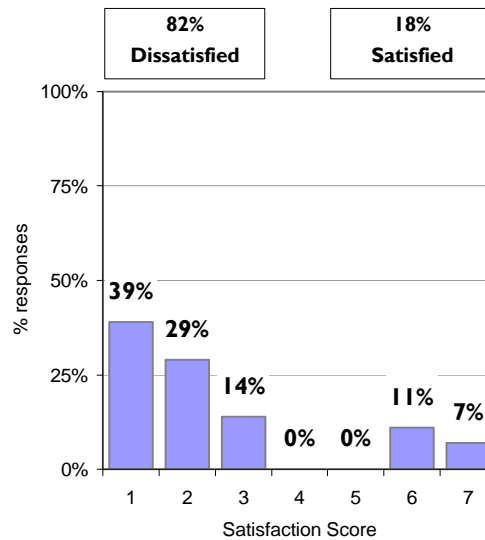

How satisfied are you with your sound privacy?

Left: Figure 4.3

Temperature satisfaction

Right: Figure 4.4

Sound privacy

4.8.3 Thermal comfort

Overall satisfaction with temperature was relatively high at 68%. When asked if thermal comfort was a factor in occupants' ability to get their work done, 61% believe it positively impacts their work experience, 32% gave neutral responses, and 7% believe it negatively impacts their work to some extent. As noted above, several comments related to occupants feeling too cold, and listed the reception area and the "warehouse door" as sources of discomfort. Several comments alluded to architectural characteristics, describing the interior as 'cavernous', and a 'large warehouse', features that may have contributed to some occupants' perception of cold temperatures.

This implies a potential for achieving even higher occupant satisfaction rates as the technology of UFAD improves. From these responses we know that few occupants in Teledesic have attempted to change the airflow within their workspace. Thus, it is interesting to speculate whether, simply by reaching down and adjusting their diffusers, could those occupants who were dissatisfied become satisfied?

Although relative humidity was low at approximately 30% (just within ASHRAE acceptable limits for winter operation) occupant satisfaction was very high, at 96%.

4.8.4 Acoustic and visual privacy

Open plan offices generally risk sacrificing acoustic and visual privacy as a tradeoff for interaction and spatial openness. This is certainly the case in Teledesic, as the open plan layout is the primary source of occupant dissatisfaction. Survey comments expressed feelings of a lack of privacy as they are seated facing into the partitions and are unable to see who is walking up behind them.

“Not private enough, too loud, very distracting...”

“...my back is to those who approach me. Therefore, rather than glance up & make eye contact, I must literally stop what I’m doing & turn around to see who is requiring assistance by walking into my cube. An irritation.”

Sound privacy was also a significant cause of complaints, as illustrated in Figure 4.4. This dissatisfaction may have multiple causes, including the unexpected low occupancy resulting in lower masking background noise levels. The dissatisfaction may be partially based on expectations, for example one occupant missed the privacy of a private office. Any occupants that may have had private offices previously would certainly be dissatisfied from the adjustment to an open office environment. However, despite the high dissatisfaction rate for the acoustic environment in general, 50% of the occupants failed to identify the level of background noise as the source of their discomfort.

4.8.5 Lighting quality

The redesign of the Teledesic space included large skylights and south-facing windows with dark metal surface of the screens for which occupants showed mixed feelings. Although a few occupants liked the daylight provided by these features, a larger number described dissatisfaction with glare from windows and direct sunlight falling directly on workspaces at certain times of the year.

“...Natural light via monitors and windows is great, but a better means to eliminate glare (direct sunlight) at certain times is sorely needed...”

Although some occupants complained of low light levels, 74% responded that they were satisfied with the amount of light in their workspace, and 61% were satisfied with their visual comfort in general. Occupants had mixed opinions regarding the effect that their visual comfort was having on their work efficiency, with 50% responding that the lighting quality positively affects their ability to do their work.

5. CONCLUSIONS AND IMPLICATIONS FOR DESIGN

The Teledesic Broadband Center had been occupied for over a year and a half when this field study was undertaken. During the course of this case study the research team found several unexpected results. The building has a large, tall volume to be conditioned, lower than estimated internal gains, and potential for significant envelope heat loss. However, the thermal environment was found to be uniform within the occupied zone, providing a high level of occupant satisfaction. The UFAD system operated as designed with little troubleshooting, with the exception of minor changes to set point temperatures during the first year when temperature extremes of winter and summer were experienced.

Previous research has shown that occupants are more content when able to control the environment of their workspace. Teledesic employees showed a strong preference for the raised floor system, possibly due to this desire for individual control. However in practice few of the occupants actually adjust the diffusers, implying that the ability to control one's environment may be the overriding issue. As this study shows, the flexibility of the UFAD system is not being exploited by building occupants and facility managers. Informing building occupants of the options of adjusting and moving diffusers (with the assistance of maintenance staff) may enhance their personal comfort.

The project as a whole has been viewed as a success. The project architects at NBBJ have received favorable feedback from occupants that the design "reflects their culture and style of working." According to the design engineers, Teledesic can serve as an example for the advantages of a UFAD installation in terms of post occupancy performance.

Although many industries have fully adopted the open office convention as the standard, this case study illustrates the common problems with this workplace approach. The primary sources of occupant complaints-acoustical and visual privacy, workplace orientation, and visual comfort-are all direct results of the open plan design (exacerbated to some extent by the low number of occupants). To create a fully functional open plan workplace, special attention needs to be paid these factors, with special consideration given to details such as partition heights, background noise levels, and desk orientation.

NOTES

1. Preliminary review of aggregate data from four CBE surveys revealed that 60-70% of occupants in open plan offices were dissatisfied with their sound privacy. The level of dissatisfaction with sound privacy at Teledesic, while significant, is only slightly worse than what may be expected in most open office situations.
2. Of the 38 temperature sensors initially installed, the data from 7 loggers were unable to be retrieved. In addition, at some stage between the two site-visits, the sensor strings either fell, or were taken, down. However the number of data loggers that yielded readings was enough for a significant analysis to be carried out.
3. Several EMCS data logs which were setup during the first visit were lost. Although this reduced the information available, there was still sufficient operational data for analysis.
4. Salter, Charles M, A Nash, C. Miyar. 1996. "Reader for Architectural Acoustics", San Francisco, CA
5. Although four channels were recorded, since the mezzanine channel reading was identical to the Main-West reading we have assumed that these are the mezzanine readings and thus have disregarded the Main-West values.
6. Webster, Tom, F. Bauman, J. Reese. 2001. "Experimental Study of the Impact of Design and Operating Conditions on Room Air Stratification in Underfloor Air Distribution (UFAD) Systems." Internal Report, Center for the Built Environment, University of California, Berkeley.
7. A study conducted by Arup concluded that 75 ft (23 m) as the upper limit for an even distribution of supply air within an un-partitioned plenum.

6. APPENDIX I: SUMMARY OF FIELD MEASUREMENTS

DATA	EQUIPMENT	TIME PERIOD
ROOM AIR TEMPERATURES, VERTICAL DISTRIBUTION	ONSET data loggers Temp loggers	6 weeks
ROOM AIR TEMPERATURES, HORIZONTAL DISTRIBUTION	Vaisalia temperature and relative humidity sensor	Spot-measurements
INTERNAL RELATIVE HUMIDITY	Vaisalia temperature and relative humidity sensor	Spot-measurements
SUPPLY AIR TEMPERATURES, PLENUM VARIATIONS	ONSET data loggers Temp loggers	6 weeks
SLAB TEMPERATURES, GROUND AND MEZZANINE	EMCS records	1 year
AHU OPERATIONAL DATA	EMCS records	1 year
VAV OPERATIONAL DATA	EMCS records	1 year
AIR VELOCITY WITHIN AND ABOVE DIFFUSERS	SOLOMAT 429 digital hot-wire anemometer	Spot-measurements
SOUND PRESSURE LEVELS ABOVE DIFFUSERS	SPL meter	Spot-measurements
INTERNAL SURFACE TEMPERATURE VARIATIONS	RAYTEK Ranger portable infrared pyrometer	Spot-measurements
OCCUPANT SATISFACTION (THERMAL COMFORT, LIGHTING, ACOUSTICS AND GENERAL WORKPLACE.)	On-line occupant survey	Relating to experiences over 6 months.